



Ingage
Connected Office

VENEER



Executive

Effective workspace with generous storage and convenient technology integration supports a wide variety of work modes, from focus and mentoring to impromptu meetings and small group interactions. The Executive setting is designed to balance concentration with collaboration and promote communication between leaders and their teams.



Office

Smart enclosed working and collaboration space supports focus work, impromptu and small group meetings or one-on-one private conversations. The office provides managers and supervisors with an effective space for mentoring and team collaboration to promote a culture of continuous learning.



Focus

Flexible, efficient space designed to accommodate individual work, impromptu meetings, informal gatherings for a few people or a quick conference call.



Efficient space is especially designed for teams to touch base and promote continuous learning, open discussions, team collaboration, brainstorming, presentations and the exchange of digital information. A high degree of technology integration and plug-and-play functions facilitate multi-tasking and interactions around media and technology.

Flex Team



Huddle

Private meeting space designed for hosting small group collaborations, brainstorming sessions or social gatherings. A huddle space can be equipped with teleconferencing or presentation facilities for efficient remote meeting, or simply used as a comfortable seating area and extension of your lifestyle at the workplace.



Conference

Effective larger meeting space ideal for hosting high-end video conferences, larger group meetings, knowledge sharing sessions, presentations or the exchange of digital information. A smart cable management solution and plug-and-play functions support multi-tasking and team collaboration within larger groups.



Product feature: designed for productivity

Executive Desk and Cabinet Combination Set



EXECUTIVE DESK



OFFICE DESK



CABINET SET



Multi-tasking workspace | Boost productivity with an effective multi-tasking work area that includes a smart cabinet with a sliding cover that doubles as additional desk space. Convenient power and USB sockets combined with a BYOD platform improves mobility and offers round-the-clock connectivity. An innovative Ingage storage system, including a three-door wardrobe, keeps everything within easy reach.

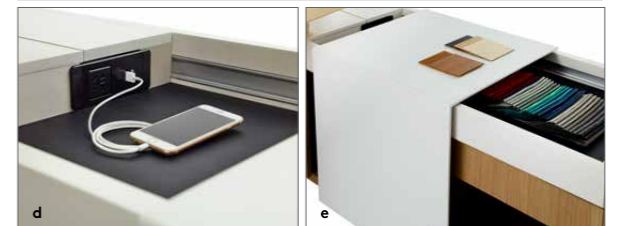
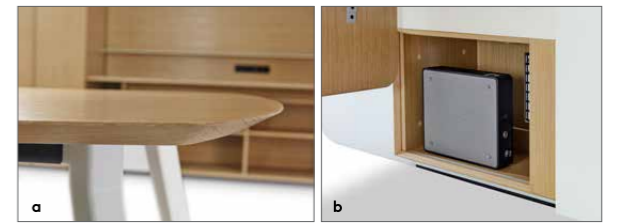

EXECUTIVE DESK WITH SMART CABINET
a SLOPE EDGE WITH SOFT ROUND CORNER **b** CPU STORAGE HIDDEN UNDER DESK **c** SIDE STORAGE **d** USB POWER SUPPORTS BYOD **e** SLIDING SURFACE

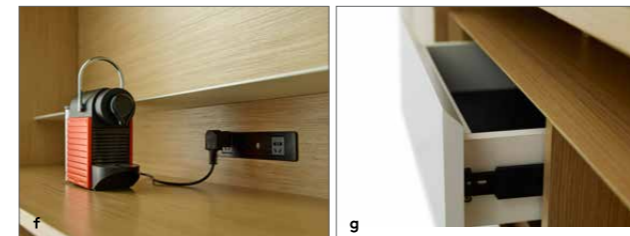

CABINET SET
f CONVENIENT POWER AND USB SOCKET SUPPORTS BYOD **g** FUNCTIONAL DRAWER WITH 45 DEGREE KNIFE EDGE DESIGN **h** SWING DOOR CABINET WITH HANGING RAIL **i** METAL SHELIVING FOR DISPLAY ITEMS



OFFICE DESK WITH EXTENDED CABINET
j USB SOCKET SUPPORTS BYOD **k** STATIONERY HOLDER

Product feature: designed for collaboration

Conference Table



Modular and extendible table | Accommodate large meetings with a modular table that grows up to 9.8m. A multiple socket tower provides easy access to power while sliding doors and hidden storage keep the surface tidy.



a CONVENIENT POWER AND USB SOCKET SUPPORTS BYOD **b** SLIDING DOOR OPENING FOR THE EASE OF CABLE MANAGEMENT **c** MODULAR DESIGN TOWER BASE ALLOWS ITS' 600MM SEGMENTS TO EXTEND THE TABLE UP TO 9.8M

Multi-media Centre

Connected team | Facilitate seamless communication, knowledge sharing and collaboration during remote team meetings with an interactive workspace including an advanced TV conference function, convenient power and USB sockets.



a CONVENIENT POWER AND USB SOCKET SUPPORTS BYOD **b** SLIDING DOOR OPENING FOR TIDY CABLE MANAGEMENT



Product feature: designed for comfort

Height Adjustable Table (HAT)

Sit-to-stand | Support alternative postures and individual working styles with a HAT intelligent control, including a memory function holding three positions, which adjusts the table height from 640mm to 1,300mm in just nine seconds.

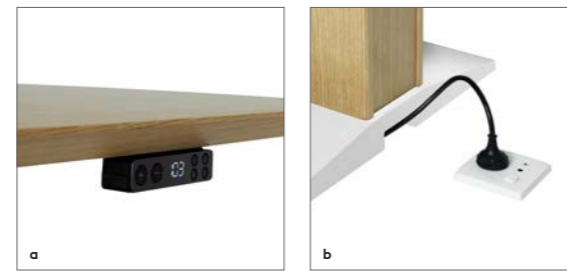

a INTELLIGENT MEMORY CONTROL
b TABLE BASE DESIGN FOR HIDDEN CABLE MANAGEMENT TO REDUCE CLUTTER

Double-layer Table

Efficient team meeting | Keep your work surfaces neat with a double-layer team table offering a convenient lower sill to rest devices. Built-in power sockets and USB ports on all sides support BYOD to enable efficient team meetings.

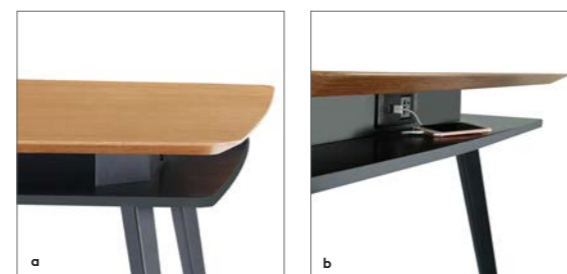

a LOWER LAYER OF TABLE SHELF TO HOLD PERSONAL DEVICE
b CONVENIENT POWER AND USB SOCKET TO SUPPORT BYOD

Sofa & Occasional Table



At home and at the office | Ensure a pleasurable seating experience combining a contemporary design with the ultimate in comfort. Gently sloping, rounded edges and corners provide the flexible move and right support for every position.



Balance and comfort | Reinforce balance and comfort with a range of occasional tables featuring fluid and organic shapes, finished with a sleek surface and sloped edges. Group different table shapes and heights to meet the needs of varying group settings in your workplace.



a SOFA BUILT-IN SIDE TABLE **b** GENTLY SLOPED EDGE SOLID WOOD AND VENEER EVOKES NATURE IN THE WORKSPACE **c** ACCENT WOOD PLATFORM BASE AND LEG **d** MOVABLE ARMREST PILLOW EASILY REPOSITIONED.
e REVERSIBLE SOFA DESIGN CAN BE RECONFIGURED EASILY **f** ELEGANTLY CRAFTED LEATHER HANDLE ALLOWS LIGHTWEIGHT STOOL TO BE EASILY LIFTED **g** CURVE ORGANIC LINES CREATE A HARMONIOUS MEETING PLACE

Room configuration: Customized your space

Executive Room Size 17 - 40 SQM

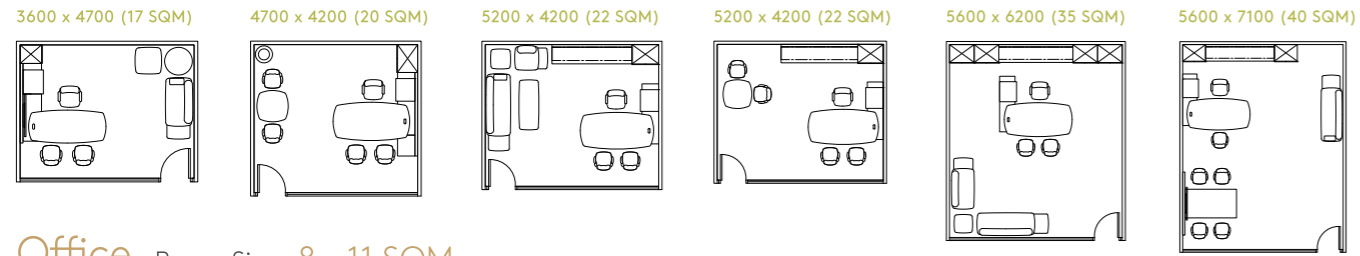

Office Room Size 8 - 11 SQM

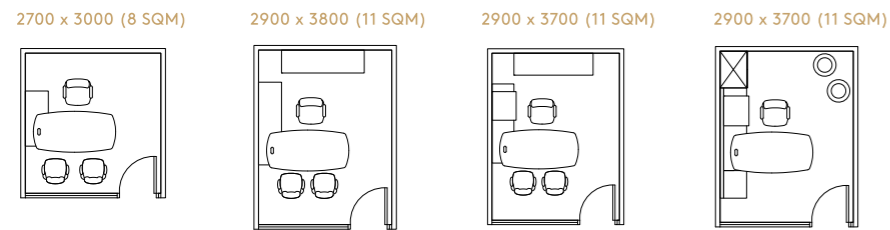

Focus Room Size 6 - 9 SQM

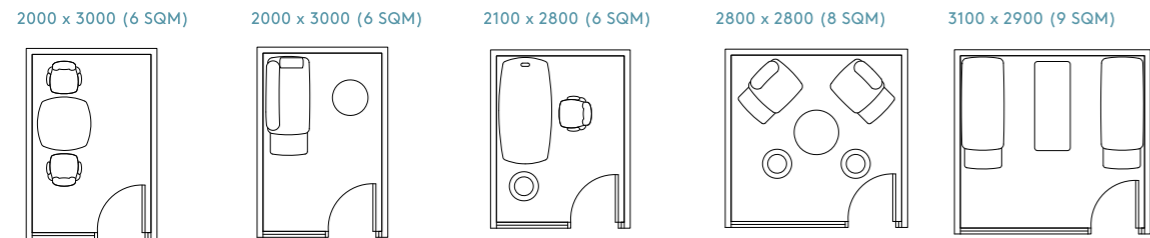

Flex Team Room Size 11 - 15 SQM

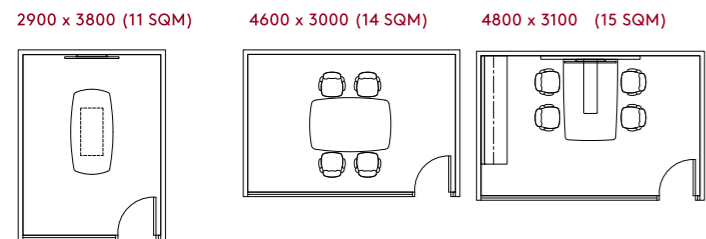

Huddle Room Size 11 - 15 SQM

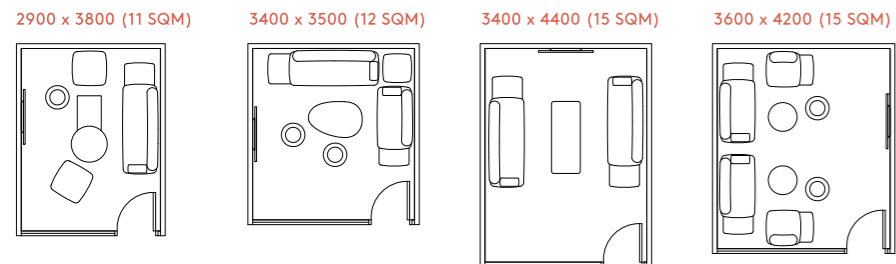

Conference Room Size 20 - 40 SQM

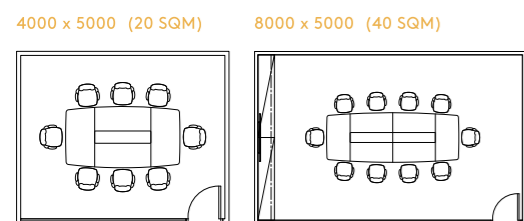

Color & material: Refresh your workplace

Dawn

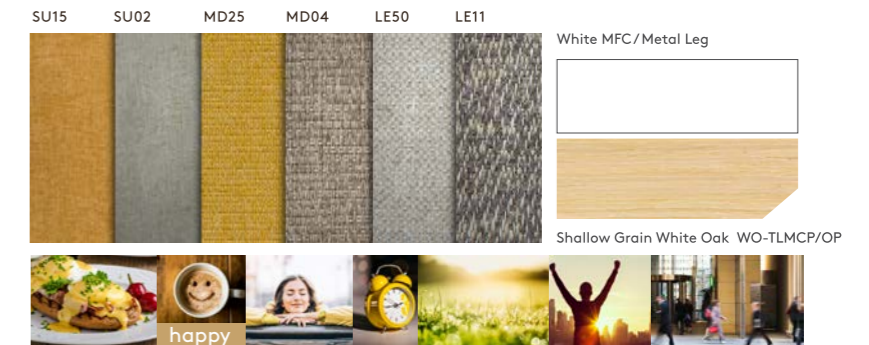

Morning

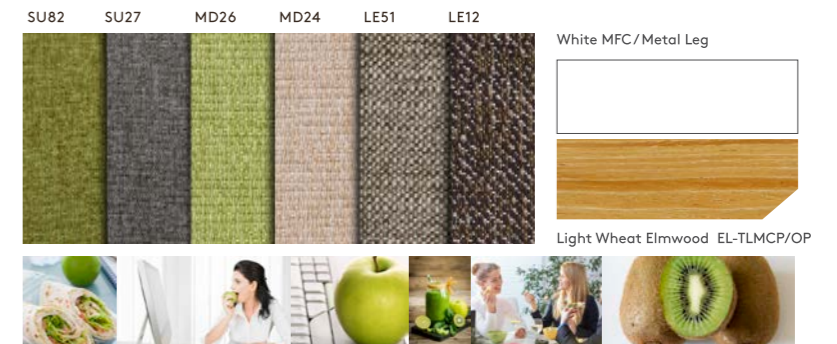

Midday

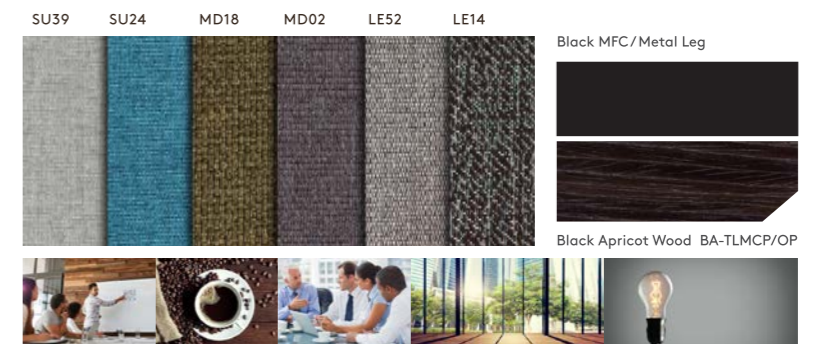

Dusk

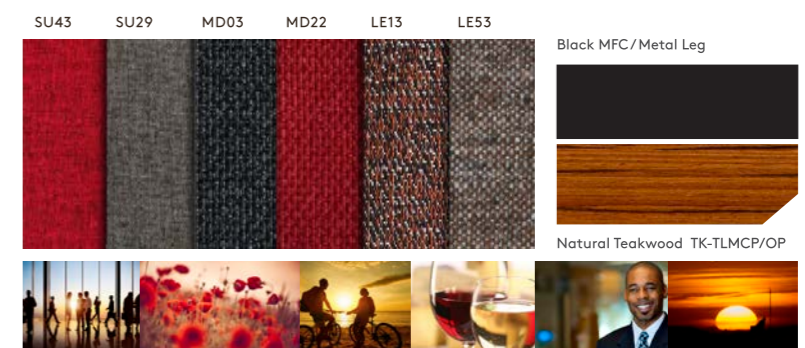

Twilight

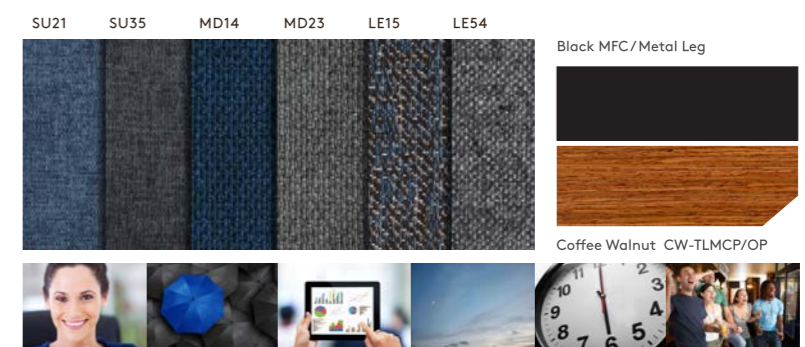

Remark: Color variations may occur on printed matters. Please refer to swatch cards or actual product sample.

Statement of Line

MAIN DESK W/SIDE CABINET

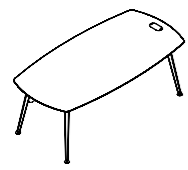

MAIN DESK
W1800 D900 H748
W2200 D1100 H748

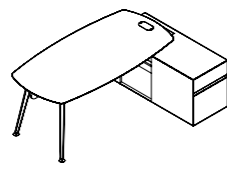

MAIN DESK W/SIDE CABINET
OVERALL SIZE
W2000 D1340 H748
W2380 D1350 H748
MAIN DESK
W1800 D900 H748
W2200 D1100 H748
SIDE CABINET
W1200 D500 H630

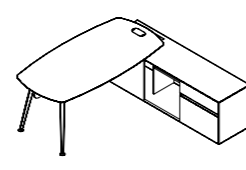

MAIN DESK W/EXTENDED CABINET
OVERALL SIZE
W2000 D1940 H748
W2380 D1950 H748
MAIN DESK
W1800 D900 H748
W2200 D1100 H748
EXTENDED CABINET
W1800 D500 H630

TEAM TABLE

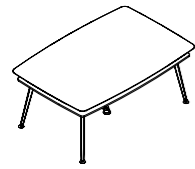

DOUBLE-LAYER TEAM TABLE
W1800 D1200 H748

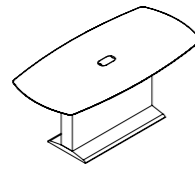

HEIGHT ADJUSTMENT TABLE (HAT)
W1800 D900 H748 (H1200)

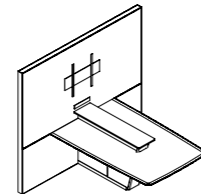

MEDIA CENTER
OVERALL SIZE
W2200 D1880 H2000 (H891)
WALL UNIT
W2200 D80 H2000
CONFERENCE TABLE
W1200 D1800 H748 (H891)

LOWER CABINET

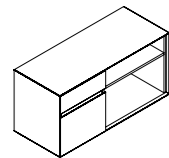

LOWER CABINET W/SINGLE SET SET OF DRAWER
W1200 D500 H630

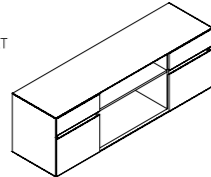

LOWER CABINET W/2 SETS OF DRAWERS
W1800 D500 H630

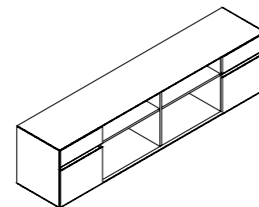

LOWER CABINET W/2 SETS OF DRAWERS
W2400 D500 H630

LOWER CABINET

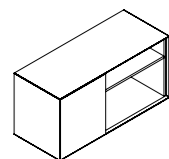

LOWER CABINET W/SINGLE SWING DOOR
W1200 D500 H630

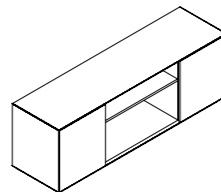

LOWER CABINET W/2 SWING DOORS
W1800 D500 H630

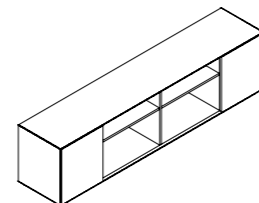

LOWER CABINET W/2 SWING DOORS
W2400 D500 H630

WARDROBE / HIGH CABINET

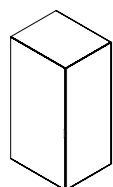

SINGLE DOOR WARDROBE
W500 D600 H1200



SINGLE 2-DOOR WARDROBE
W500 D600 H2000

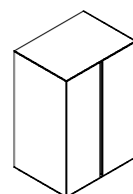

2-DOOR WARDROBE
W800 D600 H1200

MAIN DESK W/SIDE CABINET

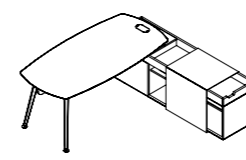

MAIN DESK W/SMART CABINET W/SLIDING SURFACE
OVERALL SIZE
W2000 D1940 H748
W2380 D2380 H748
MAIN DESK
W1800 D900 H748
W2200 D1100 H748
SMART CABINET W/SLIDING SURFACE
W1800 D500 H630
W2200 D500 H630

MEETING TABLE

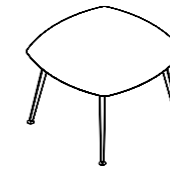

MEETING TABLE
W900 D900 H748
W1200 D1200 H748

CONFERENCE TABLE

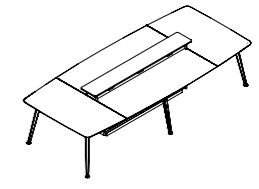

CONFERENCE TABLE
W2800 D1500 H748 (H891)
W3400 D1500 H748 (H891)
W4000 D1500 H748 (H891)

PEDESTAL

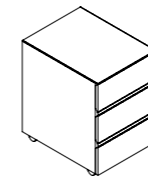

PEDESTAL
W426 D550 H630

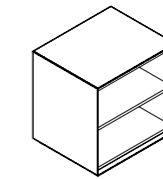

OPEN SHELF STORAGE
W600 D500 H630

LOWER CABINET

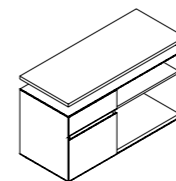

LOWER CABINET W/SINGLE SET OF DRAWER W/PLATE
W1200 D500 H745

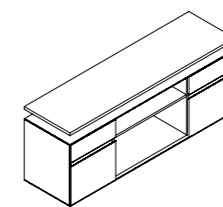

LOWER CABINET W/2 SETS OF DRAWERS W/PLATE
W1800 D500 H745

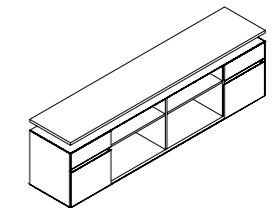

LOWER CABINET W/2 SETS OF DRAWERS W/PLATE
W2400 D500 H745

LOWER CABINET

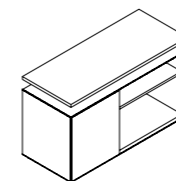

LOWER CABINET W/SINGLE SWING DOOR W/PLATE
W1200 D500 H745

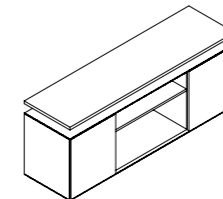

LOWER CABINET W/2 SWING DOORS W/PLATE
W1800 D500 H745

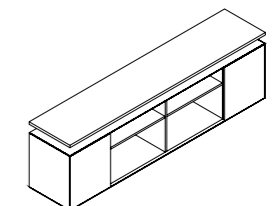

LOWER CABINET W/2 SWING DOORS W/PLATE
W2400 D500 H745

WARDROBE / HIGH CABINET

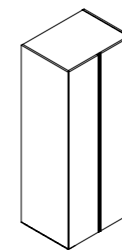

2-DOOR WARDROBE
W800 D600 H2000

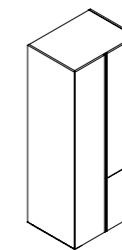

3-DOOR WARDROBE
W800 D600 H2000

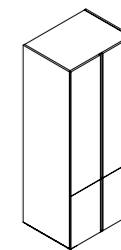

4-DOOR CABINET, W/O HANGER
W800 D600 H2000

Statement of Line

ACCESSORY

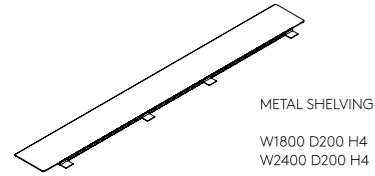

METAL SHELVING
W1800 D200 H4
W2400 D200 H4

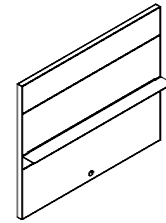

WORK WALL UNIT W/METAL SHELVING
HANGING CABINET/LOWER CABINET
MAIN DESK W/EXTENDED CABINET
MAIN DESK W/SMART CABINET

W1800 D280 H1200
W2400 D280 H1200
W1800 D280 H2000
W2400 D280 H2000

OFFICE / EXECUTIVE MAIN DESK & CABINET SET

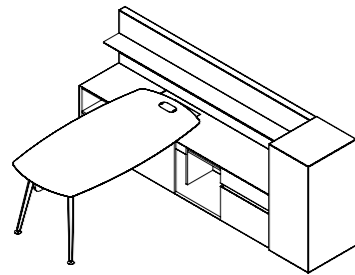

OFFICE: MAIN DESK W/EXTENDED CABINET AND LOW WALL UNIT CABINET SET

OVERALL SIZE:
W2900 D2080 H1200

MAIN DESK W/EXTENDED CABINET
WORK WALL UNIT W/METAL SHELVING
OPEN SHELF STORAGE
SINGLE DOOR WARDROBE

OPTION(S):
WARDROBE: 2-DOOR WARDROBE

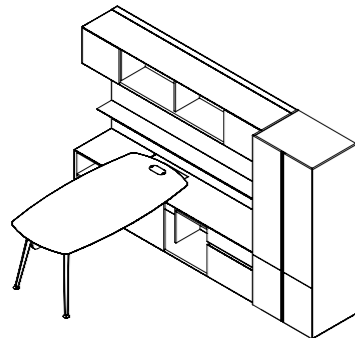

EXECUTIVE: MAIN DESK W/EXTENDED CABINET AND HIGH WALL UNIT CABINET SET

OVERALL SIZE:
W3200 D2080 H2000

MAIN DESK W/EXTENDED CABINET
WORK WALL UNIT W/METAL SHELVING
HANGING CABINET
OPEN SHELF STORAGE
4-DOOR CABINET

OPTION(S):
WARDROBE: SINGLE 2-DOOR WARDROBE, 2-DOOR WARDROBE, 3-DOOR WARDROBE

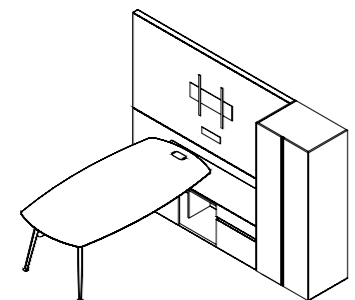

EXECUTIVE: MAIN DESK W/EXTENDED CABINET AND TV MOUNT WORK WALL UNIT CABINET SET

OVERALL SIZE:
W3200 D2080 H2000
W3200 D2460 H2000

MAIN DESK W/EXTENDED CABINET
WORK WALL UNIT W/TV MOUNT
2-DOOR WARDROBE

OPTION(S):
WARDROBE: SINGLE 2-DOOR, 3-DOOR WARDROBE, 4-DOOR CABINET
STORAGE: OPEN SHELF STORAGE

ACCESSORY

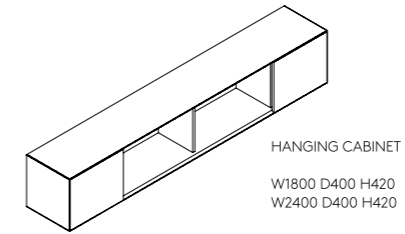

HANGING CABINET
W1800 D400 H420
W2400 D400 H420

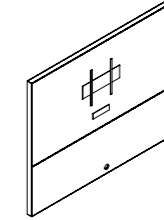

WORK WALL UNIT W/TV MOUNT

OPTION(S):
MAIN DESK W/EXTENDED CABINET
MAIN DESK W/SMART CABINET

W2400 D80 H2000

OFFICE / EXECUTIVE MAIN DESK & CABINET SET

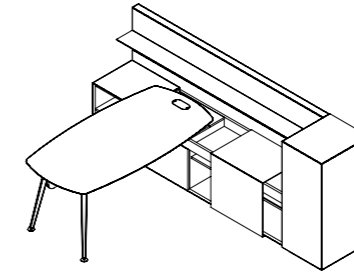

OFFICE: MAIN DESK W/SMART CABINET AND LOW WALL UNIT CABINET SET

OVERALL SIZE:
W2900 D2080 H1200

MAIN DESK W/SMART CABINET W/SLIDING SURFACE
WORK WALL UNIT W/METAL SHELVING
OPEN SHELF STORAGE
SINGLE DOOR WARDROBE

OPTION(S):
WARDROBE: 2-DOOR WARDROBE

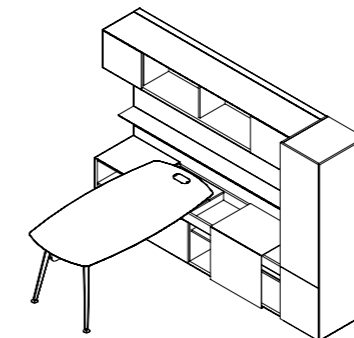

EXECUTIVE: MAIN DESK W/SMART CABINET AND HIGH WALL UNIT CABINET SET

OVERALL SIZE:
W2900 D2080 H2000

MAIN DESK W/SMART CABINET, W/SLIDING SURFACE:
WORK WALL UNIT W/METAL SHELVING
HANGING CABINET
OPEN SHELF STORAGE
SINGLE 2-DOOR WARDROBE

OPTION(S):
WARDROBE: 2-DOOR WARDROBE, 3-DOOR WARDROBE, 4-DOOR CABINET

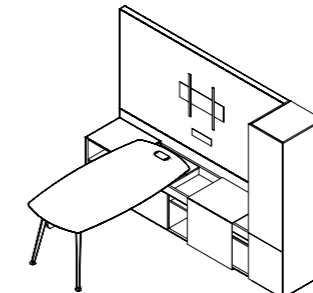

EXECUTIVE: MAIN DESK W/SMART CABINET AND TV MOUNT WORK WALL UNIT CABINET SET

OVERALL SIZE:
W2900 D2080 H2000

MAIN DESK W/SMART CABINET, W/SLIDING SURFACE
WORK WALL UNIT W/TV MOUNT
OPEN SHELF STORAGE
SINGLE 2-DOOR WARDROBE

OPTION(S):
WARDROBE: 2-DOOR WARDROBE, 3-DOOR WARDROBE, 4-DOOR CABINET

Statement of Line

OFFICE / EXECUTIVE MAIN DESK & CABINET SET

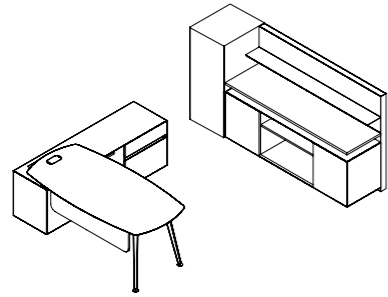

OFFICE: MAIN DESK W/EXTENDED CABINET AND LOW WALL CABINET UNIT SET

MAIN DESK W/EXTENDED SIDE CABINET:
W2000 D1940 H748
W2380 D1950 H748

WORK WALL UNIT W/METAL SHELVING
LOWER CABINET W/2 SWING DOORS
SINGLE DOOR WARDROBE

OPTION(S):
MAIN DESK W/SIDE CABINET
MAIN DESK W/SMART CABINET, W/SLIDING SURFACE

WALL UNIT AND CABINET

LOWER CABINET:
LOWER CABINET W/2 SETS OF DRAWERS
LOWER CABINET W/2 SETS OF DRAWERS W/PLATE
LOWER CABINET W/2 SWING DOORS

WARDROBE:
2-DOOR WARDROBE

OFFICE DESK / EXECUTIVE DESK SET COMBINATION SET

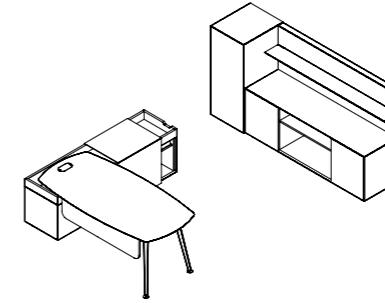

OFFICE: MAIN DESK W/SMART CABINET AND LOW WALL CABINET UNIT SET

MAIN DESK W/SMART CABINET W/SLIDING SURFACE:
W2000 D1940 H748
W2380 D2380 H748

WORK WALL UNIT W/METAL SHELVING
LOWER CABINET W/2 SWING DOORS
SINGLE DOOR WARDROBE

OPTION(S):
MAIN DESK W/SIDE CABINET
MAIN DESK W/EXTENDED CABINET

WALL UNIT AND CABINET

LOWER CABINET:
LOWER CABINET W/2 SETS OF DRAWERS
LOWER CABINET W/2 SETS OF DRAWERS W/PLATE
LOWER CABINET W/2 SWING DOORS W/PLATE

WARDROBE:
2-DOOR WARDROBE

EXECUTIVE: OFFICE DESK SET W/EXTENDED CABINET AND HIGH WALL UNIT CABINET SET

MAIN DESK W/EXTENDED CABINET:
W2000 D1940 H748
W2380 D1950 H748

WORK WALL UNIT W/METAL SHELVING
HANGING CABINET
LOWER CABINET W/2 SWING DOORS W/PLATE
3-DOOR WARDROBE

OPTION(S):
MAIN DESK W/SIDE CABINET
MAIN DESK W/SMART CABINET, W/SLIDING SURFACE

WALL UNIT AND CABINET

LOWER CABINET:
LOWER CABINET W/2 SETS OF DRAWERS
LOWER CABINET W/2 SETS OF DRAWERS W/PLATE
LOWER CABINET W/2 SWING DOORS

WARDROBE:
SINGLE 2-DOOR WARDROBE, 2-DOOR WARDROBE AND
4-DOOR CABINET

EXECUTIVE: MAIN DESK W/SMART CABINET AND HIGH WALL UNIT CABINET SET

MAIN DESK W/SMART CABINET W/SLIDING SURFACE
W2000 D1940 H748
W2380 D2380 H748

WORK WALL UNIT W/METAL SHELVING
HANGING CABINET
LOWER CABINET W/2 SETS OF DRAWERS W/PLATE
SINGLE DOOR WARDROBE

OPTION(S):
MAIN DESK W/SIDE CABINET
MAIN DESK W/EXTENDED SIDE CABINET

WALL UNIT AND CABINET

LOWER CABINET:
LOWER CABINET W/2 SETS OF DRAWERS
LOWER CABINET W/2 SWING DOORS
LOWER CABINET W/2 SWING DOORS W/PLATE

WARDROBE:
2-DOOR WARDROBE, 3-DOOR WARDROBE AND 4-DOOR CABINET

SOFA

1-SEATER SOFA, W/SIDE TABLE

W955 D760 H776

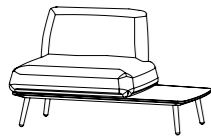

2-SEATER SOFA, W/SIDE TABLE

W1630 D760 H776

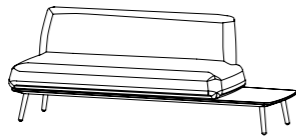

3-SEATER SOFA, W/SIDE TABLE

W2250 D760 H776

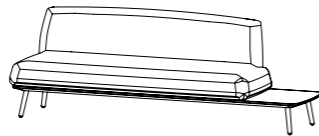

SOFA

BENCH, W/SIDE TABLE

W1850 D720 H415



OTTOMAN

W720 D720 H415



ARMREST

W370 D170 H123

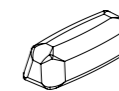

STOOL

Ø467 H520



OCCASIONAL

ROUND TABLE

Ø600 H385
Ø750 H385



SQUARE TABLE

W600 D600 H385
W750 D750 H385
W750 D750 H500



RECTANGLE TABLE

W1200 D600 H385
W1500 D600 H385
W1500 D600 H500

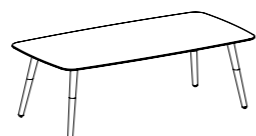

OCCASIONAL TABLE

BOX TABLE

W500 D500 H360
W750 D500 H360

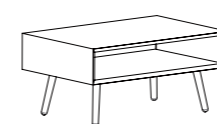

EGG (ORGANIC) TABLE

W1120 D750 H385





Office & Showroom

Shanghai
5F, Tower 3, Raffles City Changning
1193 Changning Road, Shanghai 200051
Tel: (86) 21 6278 8888

Guangzhou
Unit 2, 22/F, Jun Lin Building,
No. 285 Forest and East Road,
Tianhe District, Guangzhou 510610
Tel: (86) 20 3892 2422

Dongguan
191 Huan Shi East Road
Tangxia Town, Dongguan City
Guangdong Province 523712
Tel: (86) 769 8203 1111

HNI Singapore
58 Duxton Road #01-01
Singapore 089522
Tel: (65) 6817 8750

Beijing
Room 1201-1202, 1209-1214,
12/F, No. 1, Easton Centre, No.18 Guangqu Road,
Chaoyang District, Beijing 100022
Tel: (86) 10 8521 7588

Shenzhen
Unit 2009, Huarong Building, No.2003
Shennan Avenue, Futian District, Shenzhen
Shenzhen City, Guangdong Province 518000
Tel : (86) 769 8203 1111 ext 31300

Hong Kong
22/F, Prosperity Millennia Plaza
663 King's Road, North Point, Hong Kong
Tel: (852) 2828 6888

Service Hotline

Mainland China: (86) 800 820 6073
Hong Kong & Asia Pacific: (852) 2828 6000

