

## Office & Showroom

### Shanghai

5F, Tower3, Raffles City Changning  
1193 Changning Road, Shanghai 200051  
Tel: (86) 21 6278 8888

### Beijing

Room 1201-1202, 1209-1214,  
12/F, No. 1, Easton Centre, No.18 Guangqu Road,  
Chaoyang District, Beijing 100022  
Tel: (86) 10 8521 7588

### Guangzhou

Unit 2, 22/F, Jun Lin Building,  
Tel: (86) 10 8521 7588  
Tianhe District, Guangzhou 510610  
Tel: (86) 20 3892 2422

### Shenzhen

Unit 2009, Huarong Building, No.2003  
Shennan Avenue, Futian District, Shenzhen  
Shenzhen City, Guangdong Province 518000  
Tel : (86) 769 8203 1111 ext 31300

### Dongguan

191 Huan Shi East Road  
Tangxia Town, Dongguan City  
Guangdong Province 523712  
Tel: (86) 769 8203 1111

### Hong Kong

22/F, Prosperity Millennia Plaza  
663 King's Road, North Point, Hong Kong  
Tel: (852) 2828 6888

### HNI Singapore

58 Duxton Road #01-01  
Singapore 089522  
Tel: (65) 6817 8750

## Service Hotline

Mainland China: (86) 800 820 6073  
Hong Kong & Asia Pacific: (852) 2828 6000

## 客户服务热线

中国大陆 : (86) 800 820 6073  
香港及亚太区 : (852) 2828 6000

Design and specification are subjected to modification without prior notice due to continuous product improvement.

鉴于不断求进，产品规格若有更改，恕不另行通知。

## 分行及展厅

### 上海

上海市长宁区路1193号长宁来福士广场3号楼5楼  
邮政编码：200051  
电话：(86) 21 6278 8888

### 北京

北京市朝阳区广渠路18号院世东国际中心  
1号12层1201-1202,1209-1214室  
邮政编码：100022  
电话：(86) 10 8521 7588

### 广州

广州市天河区林和东路285号  
峻林大厦22层02单元  
邮政编码：510610  
电话：(86) 20 3892 2422

### 深圳

深圳市福田区深南大道2003号  
华嵘大厦2009单元  
邮政编码：518000  
电话：(86) 769 8203 1111 ext 31300

### 东莞

中国广东省东莞市塘厦  
环市东路191号  
邮政编码：523712  
电话：(86) 769 8203 1111

### 香港

香港北角英皇道663号  
泓富产业千禧广场22楼  
电话：(852) 2828 6888

# Storage • 文件储存系列



# STORAGE 文件储存系列

## Smarten Up Your Space 优化空间 高效整洁

A tidy, organized office is where productivity and efficiency thrive. Every workplace requires smart storage solutions to perform at its optimum, but this is especially true for open-plan spaces, which need to combat clutter while retaining an open, inviting feel that inspires teamwork. Our comprehensive range offers an extensive variety of sizes, colors and finishes designed to slot seamlessly into your space, while keeping it immaculate and running like clockwork.

整洁有序的办公室环境可大幅提高工作效率。每一个工作环境都需寻找明智的存储方案，以达到最大优化，开放式办公室尤其需要避免杂乱无章，保持开放且和谐的氛围来激发团队合作。美时的存储系列全面覆盖各种尺寸、颜色和饰面，保证完美融入您的办公空间，使工作有条不紊地进行。





## Clean and Classic 净美线条 呈现经典

While its traditional wood design is timeless, the Ergo series has a stylish and modern edge. Its clean and simple aesthetic supports an assortment of workplace layouts, with extensive size, color and finishing choices. Effective business organization is achieved through its sturdy and utilitarian setups, encompassing sliding and hinged door options, open bookcases, wardrobe setups and mobile pedestals.

雅歌系列采用传统木质设计，经久永恒，而不失独特风格和现代感。雅歌系列提供各种尺寸、颜色和饰面的选择，净美及简洁的审美理念适合多种工作环境布局。移门和掩门柜，书柜，衣柜和活动抽屉柜质地坚实且实用效果显著，可打造高效的办公环境。

## Color Options 颜色选择



Grey  
(MFG)  
灰色

Warm White  
(MFH)  
暖白色

Maple  
(MFP)  
枫木色

Cherry  
(MFY)  
樱桃木色

Red Maple  
(MFA)  
红枫木色

Black Oak  
(MFO)  
黑橡木色

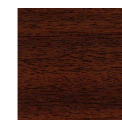

Sunlight Ash  
(MFAS)\*  
晨光白蜡木



Vintage sh  
(MFAV)\*  
复古白蜡木

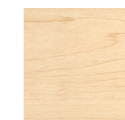

Chocolate Ash  
(MFAC)\*  
巧克力白蜡木

\*New Color 新颜色

# MCG

## 钢制文件柜



### Strength and Style

#### 坚实质地 独具风格

The MCG series blends functionality with style in a single collection presenting multiple benefits. Made of highly durable steel, the attractive and adaptable range caters to every workspace setting, be it individual or collaborative, private or public. Encouraging workplace clarity and confidence, these contemporary and practical storage creations ensure your office stays as well groomed as its staff.

钢柜系列风格独特，兼具实用性和时尚感，带来多重功用。钢质坚实，外观美丽，适合个人、合作、私人、公开等各种办公环境。时髦且实用的存储布局提升工作场所的整洁度和品位，就像员工的衣着一般整洁得体。

### Color Options

#### 颜色选择



Clear Beige  
(L)  
清杏色

Grey  
(G)  
灰色

Warm White  
(H)  
暖白色

Silver  
(S)  
银色

Charcoal  
(M)  
金属炭灰色

## Mix and Match 混搭风格 优雅多元

The intelligent MCG series anticipates almost every storage need, with an array of interchangeable options, such as roller shutter, hinged and sliding doors; lateral filing cabinets; open bookcases; lockers; and mobile pedestals. Keeping in mind that practicality is only half the story when it comes to office design, a multitude of colors and finishes inspire style and elegance.

钢柜系列提供卷门、掩门和移门文件柜、横斗式文件柜、书柜、储物柜和活动抽屉柜等互换选择，可满足各种存储需求。实用性只是办公设计的一部分，各种色彩和饰面呈现优雅风格与品质。



# COMPACTUS 推柜

## A Creative Space 办公空间 创意无限

As businesses grow, so does the pressure on them to optimize their workspace usage. Compactus has been designed with high volume and large density challenges in mind, offering practical storage sets with minimal complexity and maximum emphasis on efficiency. Made of highly durable steel, Compactus incorporates manual and mechanical system options, steel castors with double bearings, aisle safety locks, and an assortment of complementary accessories.

随着公司业务的扩大，对优化办公空间提出更高要求。推柜的设计突出解决高容量和密度大的存储挑战，提供简单易用和优化效率的实用存储产品。推柜钢质坚实，提供手推和手挽选择，双轴承钢质脚轮、通道安全锁和一系列配件。

## Color Options 颜色选择



## Details 详细

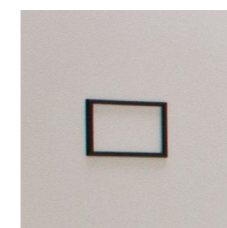

Index holder  
目录座

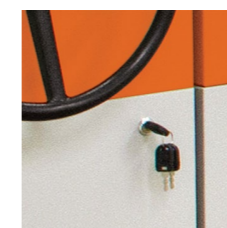

System lock  
组合柜锁



Bumper  
防撞胶垫



Pushing handle  
推手



Wheel handle with aisle safety lock  
转盘带通道安全锁

## Accessories 配件



Pull-Out Frame  
活动文件挂架

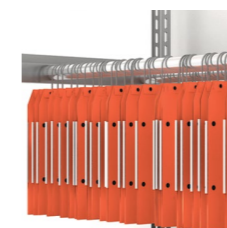

Hanging Rod  
文件袋挂通



Mobile Shelf  
活动层板

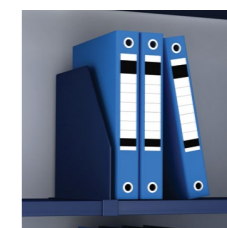

Shelf Divider  
层板分隔板



Pull-Out Desk Top  
活动台面板

# Statement of Line

## 详细说明

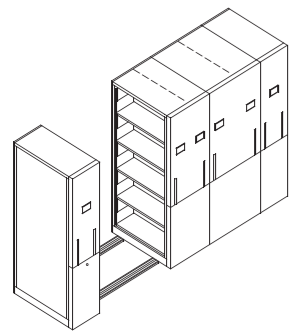

Manual Type Compactus (801)  
手推柜

1Bay 1连

Single Face Fixed 单面固定柜 (1A) W1000 / W1200 / W1500 x D460 x H2100 / H2480  
Single Face Mobile 单面活动柜 (1B) W1000 / W1200 / W1500 x D460 x H2100 / H2480  
Double Face Mobile 双面活动柜 (1C1) W1000 / W1200 / W1500 x D860 x H2100 / H2480  
Double Face Mobile 双面活动柜 (1C2) W1000 / W1200 / W1500 x D660 x H2100 / H2480  
Double Face Mobile 双面活动柜 (1C3) W1000 / W1200 / W1500 x D550 x H2100 / H2480

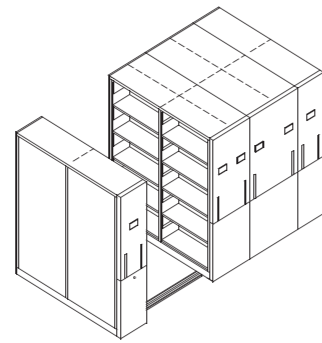

2Bays 2连

Single Face Fixed 单面固定柜 (2A) W1500 / W1886 / W2000 x D460 x H2100 / H2480  
Single Face Mobile 单面活动柜 (2B) W1500 / W1886 / W2000 x D460 x H2100 / H2480  
Double Face Mobile 双面活动柜 (2C1) W1500 / W1886 / W2000 x D860 x H2100 / H2480  
Double Face Mobile 双面活动柜 (2C2) W1500 / W1886 / W2000 x D660 x H2100 / H2480  
Double Face Mobile 双面活动柜 (2C3) W1500 / W1886 / W2000 x D550 x H2100 / H2480

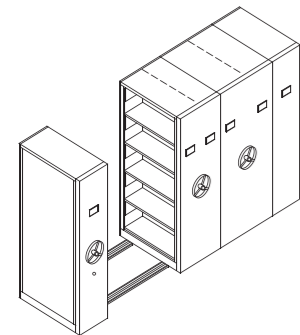

Mechanical Type Compactus (802)  
手推柜

1Bay 1连

Single Face Fixed 单面固定柜 (1A) W1000 / W1200 / W1500 x D460 x H2100 / H2480  
Single Face Mobile 单面活动柜 (1B) W1000 / W1200 / W1500 x D460 x H2100 / H2480  
Double Face Mobile 双面活动柜 (1C1) W1000 / W1200 / W1500 x D860 x H2100 / H2480  
Double Face Mobile 双面活动柜 (1C2) W1000 / W1200 / W1500 x D660 x H2100 / H2480  
Double Face Mobile 双面活动柜 (1C3) W1000 / W1200 / W1500 x D550 x H2100 / H2480

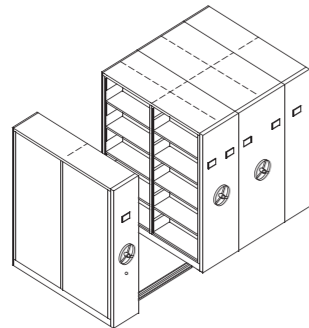

2Bays 2连

Single Face Fixed 单面固定柜 (2A) W1500 / W1886 / W2000 / W2100 / W2300 / W2500 x D460 x H2100 / H2480  
Single Face Mobile 单面活动柜 (2B) W1500 / W1886 / W2000 / W2100 / W2300 / W2500 x D460 x H2100 / H2480  
Double Face Mobile 双面活动柜 (2C1) W1500 / W1886 / W2000 / W2100 / W2300 / W2500 x D860 x H2100 / H2480  
Double Face Mobile 双面活动柜 (2C2) W1500 / W1886 / W2000 / W2100 / W2300 / W2500 x D660 x H2100 / H2480  
Double Face Mobile 双面活动柜 (2C3) W1500 / W1886 / W2000 / W2100 / W2300 / W2500 x D550 x H2100 / H2480

3Bays 3连

Single Face Fixed 单面固定柜 (3A) W2760 / W3000 / W3360 x D460 x H2100 / H2480  
Single Face Mobile 单面活动柜 (3B) W2760 / W3000 / W3360 x D460 x H2100 / H2480  
Double Face Mobile 双面活动柜 (3C1) W2760 / W3000 / W3360 x D860 x H2100 / H2480  
Double Face Mobile 双面活动柜 (3C2) W2760 / W3000 / W3360 x D660 x H2100 / H2480  
Double Face Mobile 双面活动柜 (3C3) W2760 / W3000 / W3360 x D550 x H2100 / H2480

4Bays 4连

Single Face Fixed 单面固定柜 (4A) W3640 / W3960 x D460 x H2100 / H2480  
Single Face Mobile 单面活动柜 (4B) W3640 / W3960 x D460 x H2100 / H2480  
Double Face Mobile 双面活动柜 (4C1) W3640 / W3960 x D860 x H2100 / H2480  
Double Face Mobile 双面活动柜 (4C2) W3640 / W3960 x D660 x H2100 / H2480  
Double Face Mobile 双面活动柜 (4C3) W3640 / W3960 x D550 x H2100 / H2480

5Bays 5连

Single Face Fixed 单面固定柜 (5A) W4520 x D460 x H2100 / H2480  
Single Face Mobile 单面活动柜 (5B) W4520 x D460 x H2100 / H2480  
Double Face Mobile 双面活动柜 (5C1) W4520 x D860 x H2100 / H2480  
Double Face Mobile 双面活动柜 (5C2) W4520 x D660 x H2100 / H2480  
Double Face Mobile 双面活动柜 (5C3) W4520 x D550 x H2100 / H2480

6Bays 6连

Single Face Fixed 单面固定柜 (6A) W5400 x D460 x H2100 / H2480  
Single Face Mobile 单面活动柜 (6B) W5400 x D460 x H2100 / H2480  
Double Face Mobile 双面活动柜 (6C1) W5400 x D860 x H2100 / H2480  
Double Face Mobile 双面活动柜 (6C2) W5400 x D660 x H2100 / H2480  
Double Face Mobile 双面活动柜 (6C3) W5400 x D550 x H2100 / H2480

7Bays 7连

Single Face Fixed 单面固定柜 (7A) W6280 x D460 x H2100 / H2480  
Single Face Mobile 单面活动柜 (7B) W6280 x D460 x H2100 / H2480  
Double Face Mobile 双面活动柜 (7C1) W6280 x D860 x H2100 / H2480  
Double Face Mobile 双面活动柜 (7C2) W6280 x D660 x H2100 / H2480  
Double Face Mobile 双面活动柜 (7C3) W6280 x D660 x H2100 / H2480

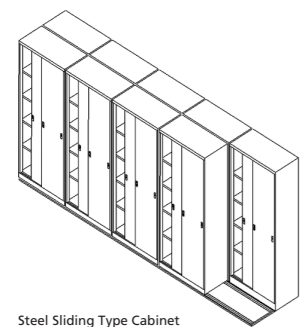

Steel Sliding Type Cabinet  
横移组合推柜

W1000 x D450 x H2130

# COMPACTUS

## 推柜

# Statement of Line

## 详细说明

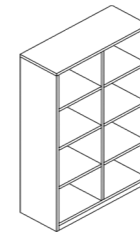

Bookcase (F4 Box Files)  
书柜 (F4文件夹)

W700 - W2000 x D400 x H745  
W700 - W2000 x D400 x H858  
W700 - W2000 x D400 x H1242  
W700 - W1200 x D400 x H1641  
W700 - W1200 x D400 x H2025

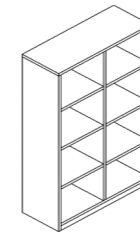

Bookcase (A4 Box Files)  
书柜 (A4文件夹)

W700 - W2000 x D400 x H794  
W700 - W2000 x D400 x H1146  
W700 - W1200 x D400 x H1513  
W700 - W1200 x D400 x H1865

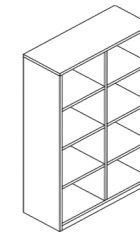

Bookcase (mix with F4 & A4 box files)  
书柜 (F4及A4文件夹混合使用)

W700 - W2000 x D400 / D475 x H745  
W700 - W2000 x D400 / D475 x H900  
W700 - W1500 x D400 / D475 x H1210  
W800 - W1200 x D400 / D475 x H1480  
W800 - W1200 x D400 / D475 x H1500  
W1000 / W1200 x D400 / D475 x H1980  
W1000 / W1200 x D400 / D475 x H2130  
(Except W1100, W1300, W1700 & W1900 除外)

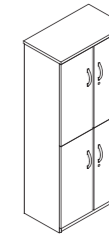

Hinged Door Cabinet (F4 Box Files)  
拉门式文件柜 (F4文件夹)

W700 - W1200 x D400 x H745  
W700 - W1200 x D400 x H858  
W700 - W1200 x D400 x H1242  
W700 - W1200 x D400 x H1641  
W700 - W1200 x D400 x H2025

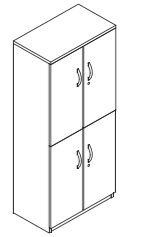

Hinged Door Cabinet (A4 Box Files)  
拉门式文件柜 (A4文件夹)

W700 - W1200 x D400 x H794  
W700 - W1200 x D400 x H1146  
W700 - W1200 x D400 x H1513  
W700 - W1200 x D400 x H1865

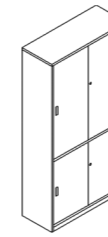

Sliding Door Cabinet (F4 Box Files)  
趟门式文件柜 (F4文件夹)

W700 - W2000 x D400 x H745  
W700 - W2000 x D400 x H858  
W700 - W2000 x D400 x H1242  
W700 - W1200 x D400 x H1641  
W700 - W1200 x D400 x H2025

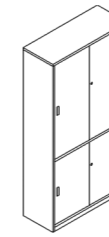

Sliding Door Cabinet (A4 Box Files)  
趟门式文件柜 (A4文件夹)

W700 - W2000 x D400 x H794  
W700 - W2000 x D400 x H1146  
W700 - W1200 x D400 x H1513  
W700 - W1200 x D400 x H1865

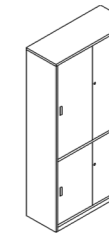

Sliding Door Cabinet  
(mix with F4 & A4 box files)  
趟门式文件柜 (F4及A4文件夹混合使用)

W700 - W2000 x D400 / D475 x H745  
W700 - W2000 x D400 / D475 x H900  
W700 - W1500 x D400 / D475 x H1210  
W800 - W1200 x D400 / D475 x H1480  
W800 - W1200 x D400 / D475 x H1500  
W1000 / W1200 x D400 / D475 x H1980  
W1000 / W1200 x D400 / D475 x H2130  
(Except W1100, W1300, W1700 & W1900 除外)

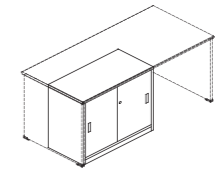

Underdesk Bookcase / Hinged Door Cabinet / Sliding Door Cabinet  
台底书柜 / 拉门式文件柜 / 趟门式文件柜

W686 - W986 x D402 x H720

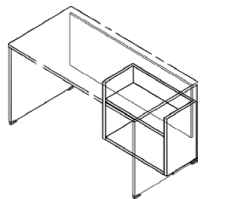

Underdesk Bookrack  
台底书架

W500 - W1000 x D330 x H570



Wardrobe, w/ Coat Hanger & 1pc shelf  
(LHS or RHS)  
衣柜·带1块活动层板及衣通  
(分左右手开门)

3C-WA-11036H W300 x D600 x H1180  
3C-WA-11046H W400 x D600 x H1180  
3C-WA-12036H W300 x D600 x H1270  
3C-WA-12046H W400 x D600 x H1270  
3C-WA-11037H W300 x D700 x H1180  
3C-WA-11047H W400 x D700 x H1180  
3C-WA-12037H W300 x D700 x H1270  
3C-WA-12047H W400 x D700 x H1270

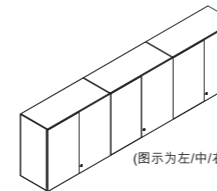

Hanging Cabinet, w/ 1pc Shelf  
(Individual, LHS, RHS or Middle)  
吊柜·带一块活动层板  
(分为独立左/右/中间四种类型)

3C-HC-0807H W700 x D440 x H850  
3C-HC-0808H W800 x D440 x H850  
3C-HC-0809H W900 x D440 x H850  
3C-HC-0810H W1000 x D440 x H850

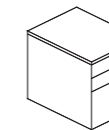

Mobile Pedestal  
活动抽屜柜

W440 x D570 x H637



Divider  
分隔板

D337 x H90

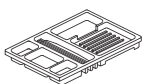

Pencil Tray  
文具架

W335 x D225 x H35

