



Office & Showroom

Shanghai

8/F, Greentech Tower
No. 436 Hengfeng Road, Jingan District
Shanghai 200070
Tel: (86) 21 6278 8888

Beijing

Building G6, C Cube Youth Cultural and Creative Park
Guangqu Road, Chaoyang District
Beijing 100020
Tel: (86) 10 8521 7588

Guangzhou

Unit 2, 22/F, Jun Lin Building
No. 285 Forest and East Road, Tianhe District
Guangzhou, Guangdong Province 510610
Tel: (86) 20 3892 2422

Shenzhen

Unit 4803A, Tower 1, Excellence Century Center
Fuhua Third Road, Futian Central District, Shenzhen
Guangdong Province 518048
Tel: (86) 769 8203 1111 ext 31018

Dongguan

191 Huan Shi East Road
Tangxia Town, Dongguan
Guangdong Province 523712
Tel: (86) 769 8203 1111

Hong Kong

26/F, FOYER, 625 King's Road
North Point, Hong Kong
Tel: (852) 2828 6888

HNI Singapore

100H Pasir Panjang Road #05-03
OC@Pasir Panjang Singapore 118524
Tel: (65) 6817 8750

分行及展厅

上海

上海市静安区恒丰路436号
环智国际大厦8层
邮政编码：200070
电话：(86) 21 6278 8888

北京

北京市朝阳区广渠路C立方青年文创园G6单元
邮政编码：100020
电话：(86) 10 8521 7588

广州

广东省广州市天河区林和东路285号
峻林大厦22层02单元
邮政编码：510610
电话：(86) 20 3892 2422

深圳

广东省深圳市福田区福华三路
卓越世纪中心1号楼4803A单元
邮政编码：518048
电话：(86) 769 8203 1111 ext 31018

东莞

广东省东莞市塘厦镇
环市东路191号
邮政编码：523712
电话：(86) 769 8203 1111

香港

香港北角英皇道625号26楼
电话：(852) 2828 6888

Service Hotline

Mainland China: (86) 800 820 6073 | (86) 400 686 8073
Hong Kong & Asia Pacific: (852) 2828 6000

客户服务热线

中国大陆：(86) 800 820 6073 | (86) 400 686 8073
香港及亚太区：(852) 2828 6000



Website 网站



WeChat 微信

Design and specification are subjected to modification without prior notice due to continuous product improvement.

鉴于不断求进，产品规格若有更改，恕不另行通知。

Storage • 文件储存系列



STORAGE 文件储存系列

Smarten Up Your Space 优化空间 高效整洁

A tidy, organized office is where productivity and efficiency thrive. Every workplace requires smart storage solutions to perform at its optimum, but this is especially true for open-plan spaces, which need to combat clutter while retaining an open, inviting feel that inspires teamwork. Our comprehensive range offers an extensive variety of sizes, colors and finishes designed to slot seamlessly into your space, while keeping it immaculate and running like clockwork.

整洁有序的办公室环境可大幅提高工作效率。每一个工作环境都需寻找明智的存储方案，以达到最大优化，开放式办公室尤其需要避免杂乱无章，保持开放且和谐的氛围来激发团队合作。美时的存储系列全面覆盖各种尺寸、颜色和饰面，保证完美融入您的办公空间，使工作有条不紊地进行。





ERGO™
雅歌



Clean and Classic 净美线条 呈现经典

While its traditional wood design is timeless, the Ergo series has a stylish and modern edge. Its clean and simple aesthetic supports an assortment of workplace layouts, with extensive size, color and finishing choices. Effective business organization is achieved through its sturdy and utilitarian setups, encompassing sliding and hinged door options, open bookcases, wardrobe setups and mobile pedestals.

雅歌系列采用传统木质设计，经久永恒，而不失独特风格和现代感。雅歌系列提供各种尺寸、颜色和饰面的选择，净美及简洁的审美理念适合多种工作环境布局。移门和掩门柜，书柜，衣柜和活动抽屉柜质地坚实且实用效果显著，可打造高效的办公环境。

Color Options 颜色选择



*New Color 新颜色

Certification
认证



GREENGUARD GOLD Indoor Air Quality Certification
荣获GREENGUARD室内空气质量金级认证

MCG

钢制文件柜



Strength and Style

坚实质地 独具风格

The MCG series blends functionality with style in a single collection presenting multiple benefits. Made of highly durable steel, the attractive and adaptable range caters to every workspace setting, be it individual or collaborative, private or public. Encouraging workplace clarity and confidence, these contemporary and practical storage creations ensure your office stays as well groomed as its staff.

钢柜系列风格独特，兼具实用性和时尚感，带来多重功用。钢质坚实，外观美丽，适合个人、合作、私人、公开等各种办公环境。时髦且实用的存储布局提升工作场所的整洁度和品位，就像员工的衣着一般整洁得体。

Color Options

颜色选择



Clear Beige
(L)
清杏色

Grey
(G)
灰色

Warm White
(H)
暖白色

Silver
(S)
银色

Charcoal
(M)
金属炭灰色

Mix and Match 混搭风格 优雅多元

The intelligent MCG series anticipates almost every storage need, with an array of interchangeable options, such as roller shutter, hinged and sliding doors; lateral filing cabinets; open bookcases; lockers; and mobile pedestals. Keeping in mind that practicality is only half the story when it comes to office design, a multitude of colors and finishes inspire style and elegance.

钢柜系列提供卷门、掩门和移门文件柜、横斗式文件柜、书柜、储物柜和活动抽屉柜等互换选择，可满足各种存储需求。实用性只是办公设计的一部分，各种色彩和饰面呈现优雅风格与品质。



COMPACTUS 推柜

A Creative Space 办公空间 创意无限

As businesses grow, so does the pressure on them to optimize their workspace usage. Compactus has been designed with high volume and large density challenges in mind, offering practical storage sets with minimal complexity and maximum emphasis on efficiency. Made of highly durable steel, Compactus incorporates manual and mechanical system options, steel castors with double bearings, aisle safety locks, and an assortment of complementary accessories.

随着公司业务的扩大，对优化办公空间提出更高要求。推柜的设计突出解决高容量和密度大的存储挑战，提供简单易用和优化效率的实用存储产品。推柜钢质坚实，提供手推和手挽选择，双轴承钢质脚轮、通道安全锁和一系列配件。

Color Options 颜色选择



Details 详细

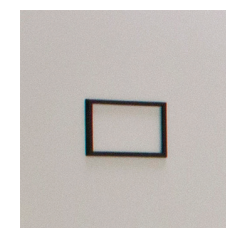

Index holder
目录座

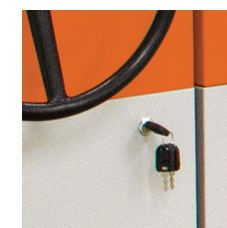

System lock
组合柜锁



Bumper
防撞胶垫



Pushing handle
推手



Wheel handle with aisle safety lock
转盘带通道安全锁

Accessories 配件



Pull-Out Frame
活动文件挂架



Hanging Rod
文件袋挂通



Mobile Shelf
活动层板

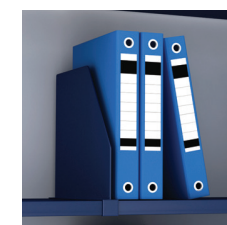

Shelf Divider
层板分隔板



Pull-Out Desk Top
活动台面板

Statement of Line 详细说明

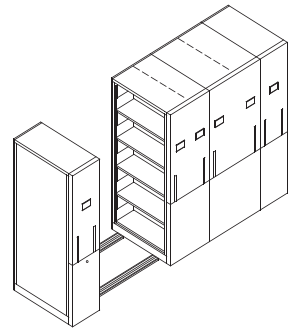

Manual Type Compactus (801)
手推柜

1Bay 1连

Single Face Fixed 单面固定柜 (1A) W1000 / W1200 / W1500 x D460 x H2100 / H2480
Single Face Mobile 单面活动柜 (1B) W1000 / W1200 / W1500 x D460 x H2100 / H2480
Double Face Mobile 双面活动柜 (1C1) W1000 / W1200 / W1500 x D860 x H2100 / H2480
Double Face Mobile 双面活动柜 (1C2) W1000 / W1200 / W1500 x D660 x H2100 / H2480
Double Face Mobile 双面活动柜 (1C3) W1000 / W1200 / W1500 x D550 x H2100 / H2480

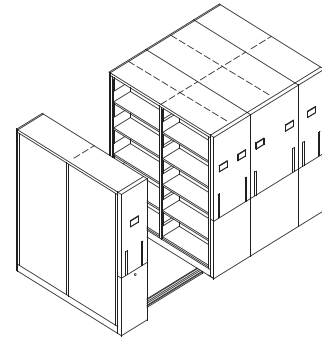

2Bays 2连

Single Face Fixed 单面固定柜 (2A) W1500 / W1886 / W2000 x D460 x H2100 / H2480
Single Face Mobile 单面活动柜 (2B) W1500 / W1886 / W2000 x D460 x H2100 / H2480
Double Face Mobile 双面活动柜 (2C1) W1500 / W1886 / W2000 x D860 x H2100 / H2480
Double Face Mobile 双面活动柜 (2C2) W1500 / W1886 / W2000 x D660 x H2100 / H2480
Double Face Mobile 双面活动柜 (2C3) W1500 / W1886 / W2000 x D550 x H2100 / H2480

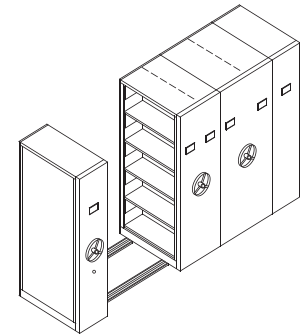

Mechanical Type Compactus (802)
手推柜

1Bay 1连

Single Face Fixed 单面固定柜 (1A) W1000 / W1200 / W1500 x D460 x H2100 / H2480
Single Face Mobile 单面活动柜 (1B) W1000 / W1200 / W1500 x D460 x H2100 / H2480
Double Face Mobile 双面活动柜 (1C1) W1000 / W1200 / W1500 x D860 x H2100 / H2480
Double Face Mobile 双面活动柜 (1C2) W1000 / W1200 / W1500 x D660 x H2100 / H2480
Double Face Mobile 双面活动柜 (1C3) W1000 / W1200 / W1500 x D550 x H2100 / H2480

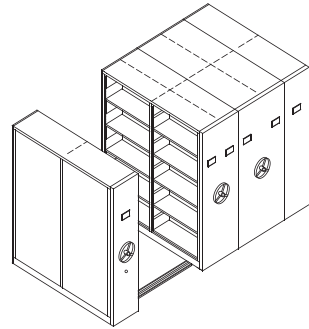

2Bays 2连

Single Face Fixed 单面固定柜 (2A) W1500 / W1886 / W2000 / W2100 / W2300 / W2500 x D460 x H2100 / H2480
Single Face Mobile 单面活动柜 (2B) W1500 / W1886 / W2000 / W2100 / W2300 / W2500 x D460 x H2100 / H2480
Double Face Mobile 双面活动柜 (2C1) W1500 / W1886 / W2000 / W2100 / W2300 / W2500 x D860 x H2100 / H2480
Double Face Mobile 双面活动柜 (2C2) W1500 / W1886 / W2000 / W2100 / W2300 / W2500 x D660 x H2100 / H2480
Double Face Mobile 双面活动柜 (2C3) W1500 / W1886 / W2000 / W2100 / W2300 / W2500 x D550 x H2100 / H2480

3Bays 3连

Single Face Fixed 单面固定柜 (3A) W2760 / W3000 / W3360 x D460 x H2100 / H2480
Single Face Mobile 单面活动柜 (3B) W2760 / W3000 / W3360 x D460 x H2100 / H2480
Double Face Mobile 双面活动柜 (3C1) W2760 / W3000 / W3360 x D860 x H2100 / H2480
Double Face Mobile 双面活动柜 (3C2) W2760 / W3000 / W3360 x D660 x H2100 / H2480
Double Face Mobile 双面活动柜 (3C3) W2760 / W3000 / W3360 x D550 x H2100 / H2480

4Bays 4连

Single Face Fixed 单面固定柜 (4A) W3640 / W3960 x D460 x H2100 / H2480
Single Face Mobile 单面活动柜 (4B) W3640 / W3960 x D460 x H2100 / H2480
Double Face Mobile 双面活动柜 (4C1) W3640 / W3960 x D860 x H2100 / H2480
Double Face Mobile 双面活动柜 (4C2) W3640 / W3960 x D660 x H2100 / H2480
Double Face Mobile 双面活动柜 (4C3) W3640 / W3960 x D550 x H2100 / H2480

5Bays 5连

Single Face Fixed 单面固定柜 (5A) W4520 x D460 x H2100 / H2480
Single Face Mobile 单面活动柜 (5B) W4520 x D460 x H2100 / H2480
Double Face Mobile 双面活动柜 (5C1) W4520 x D860 x H2100 / H2480
Double Face Mobile 双面活动柜 (5C2) W4520 x D660 x H2100 / H2480
Double Face Mobile 双面活动柜 (5C3) W4520 x D550 x H2100 / H2480

6Bays 6连

Single Face Fixed 单面固定柜 (6A) W5400 x D460 x H2100 / H2480
Single Face Mobile 单面活动柜 (6B) W5400 x D460 x H2100 / H2480
Double Face Mobile 双面活动柜 (6C1) W5400 x D860 x H2100 / H2480
Double Face Mobile 双面活动柜 (6C2) W5400 x D660 x H2100 / H2480
Double Face Mobile 双面活动柜 (6C3) W5400 x D550 x H2100 / H2480

7Bays 7连

Single Face Fixed 单面固定柜 (7A) W6280 x D460 x H2100 / H2480
Single Face Mobile 单面活动柜 (7B) W6280 x D460 x H2100 / H2480
Double Face Mobile 双面活动柜 (7C1) W6280 x D860 x H2100 / H2480
Double Face Mobile 双面活动柜 (7C2) W6280 x D660 x H2100 / H2480
Double Face Mobile 双面活动柜 (7C3) W6280 x D660 x H2100 / H2480

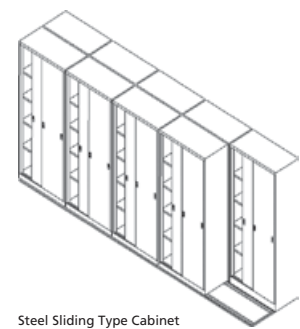

Steel Sliding Type Cabinet
横移组合推柜

W1000 x D450 x H2130

COMPACTUS 推柜

Statement of Line 详细说明

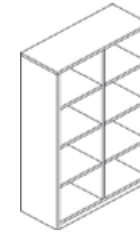

Bookcase (F4 Box Files)
书柜 (F4文件架)

W700 - W2000 x D400 x H745
W700 - W2000 x D400 x H858
W700 - W2000 x D400 x H1242
W700 - W1200 x D400 x H1641
W700 - W1200 x D400 x H2025

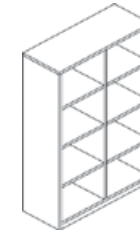

Bookcase (A4 Box Files)
书柜 (A4文件架)

W700 - W2000 x D400 x H794
W700 - W2000 x D400 x H1146
W700 - W1200 x D400 x H1513
W700 - W1200 x D400 x H1865

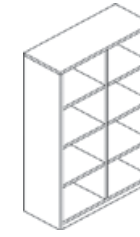

Bookcase (mix with F4 & A4 box files)
书柜 (F4及A4文件架混合使用)

W700 - W2000 x D400 / D475 x H745
W700 - W2000 x D400 / D475 x H900
W700 - W1500 x D400 / D475 x H1210
W800 - W1200 x D400 / D475 x H1480
W800 - W1200 x D400 / D475 x H1500
W1000 / W1200 x D400 / D475 x H1980
W1000 / W1200 x D400 / D475 x H2130
(Except W1100, W1300, W1700 & W1900
(W1100, W1300, W1700 & W1900 除外))

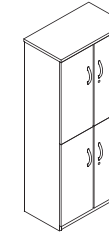

Hinged Door Cabinet (F4 Box Files)
拉门式文件柜 (F4文件架)

W700 - W1200 x D400 x H745
W700 - W1200 x D400 x H858
W700 - W1200 x D400 x H1242
W700 - W1200 x D400 x H1641
W700 - W1200 x D400 x H2025

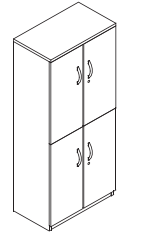

Hinged Door Cabinet (A4 Box Files)
拉门式文件柜 (A4文件架)

W700 - W1200 x D400 x H794
W700 - W1200 x D400 x H1146
W700 - W1200 x D400 x H1513
W700 - W1200 x D400 x H1865

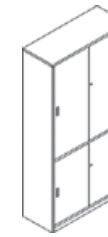

Sliding Door Cabinet (F4 Box Files)
趟门式文件柜 (F4文件架)

W700 - W2000 x D400 x H745
W700 - W2000 x D400 x H858
W700 - W2000 x D400 x H1242
W700 - W1200 x D400 x H1641
W700 - W1200 x D400 x H2025

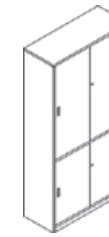

Sliding Door Cabinet (A4 Box Files)
趟门式文件柜 (A4文件架)

W700 - W2000 x D400 x H794
W700 - W2000 x D400 x H1146
W700 - W1200 x D400 x H1513
W700 - W1200 x D400 x H1865

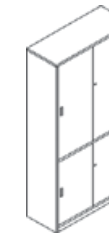

Sliding Door Cabinet
(mix with F4 & A4 box files)
趟门式文件柜 (F4及A4文件架混合使用)

W700 - W2000 x D400 / D475 x H745
W700 - W2000 x D400 / D475 x H900
W700 - W1500 x D400 / D475 x H1210
W800 - W1200 x D400 / D475 x H1480
W800 - W1200 x D400 / D475 x H1500
W1000 / W1200 x D400 / D475 x H1980
W1000 / W1200 x D400 / D475 x H2130
(Except W1100, W1300, W1700 & W1900
(W1100, W1300, W1700 & W1900 除外))

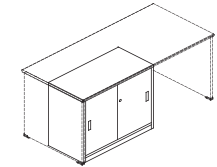

Underdesk Bookcase / Hinged Door Cabinet / Sliding Door Cabinet
台底书柜 / 拉门式文件柜 / 趟门式文件柜

W686 - W986 x D402 x H720

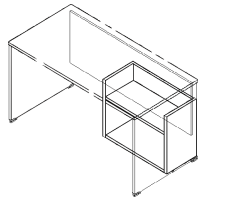

Underdesk Bookrack
台底书架

W500 - W1000 x D330 x H570

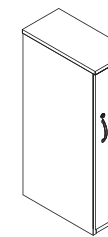

Wardrobe, w/ Coat Hanger & 1pc shelf
(LHS or RHS)
衣柜, 带1块活动层板及衣通
(分左/右手开门)

3C-WA-11036H W300 x D600 x H1180
3C-WA-11046H W400 x D600 x H1180
3C-WA-12036H W300 x D600 x H1270
3C-WA-12046H W400 x D600 x H1270
3C-WA-11037H W300 x D700 x H1180
3C-WA-11047H W400 x D700 x H1180
3C-WA-12037H W300 x D700 x H1270
3C-WA-12047H W400 x D700 x H1270

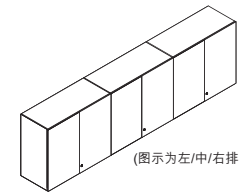

Hanging Cabinet, w/ 1pc Shelf
(Individual, LHS, RHS or Middle)
吊柜, 带一块活动层板
(分为独立左/右/中/右排列)

3C-HC-0807H W700 x D440 x H850
3C-HC-0808H W800 x D440 x H850
3C-HC-0809H W900 x D440 x H850
3C-HC-0810H W1000 x D440 x H850

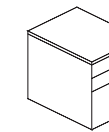

Mobile Pedestal
活动抽屜柜

W440 x D570 x H637



Divider
分隔板

D337 x H90

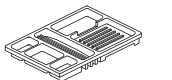

Pencil Tray
文具架

W335 x D225 x H35

Statement of Line

详细说明

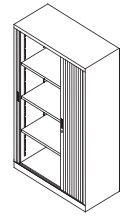

Roller Shutter Door Cabinet
卷门文件柜

W800 - W1600 x D470 x H710
W800 - W1600 x D470 x H900
W800 - W1600 x D470 x H1020
W800 - W1600 x D470 x H1250
W800 - W1600 x D470 x H1400
W800 - W1400 x D470 x H1500
W800 - W1400 x D470 x H1630
W800 - W1400 x D470 x H1800
W800 - W1400 x D470 x H1980
W800 - W1400 x D470 x H2100

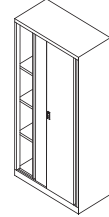

Sliding Door Cabinet
移门文件柜

W800 - W1600 x D450 x H710
W800 - W1600 x D450 x H900
W800 - W1600 x D450 x H1020
W800 - W1600 x D450 x H1250
W800 - W1600 x D450 x H1400
W800 - W1600 x D450 x H1500
W800 - W1200 x D450 x H1630
W800 - W1200 x D450 x H1800
W800 - W1200 x D450 x H1980
W800 - W1200 x D450 x H2100
W800 - W1200 x D450 x H2400

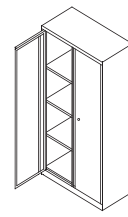

Hinged Door Cabinet
掩门文件柜

W800 - W1200 x D450 x H710
W800 - W1200 x D450 x H900
W800 - W1200 x D450 x H1020
W800 - W1200 x D450 x H1250
W800 - W1200 x D450 x H1400
W800 - W1200 x D450 x H1500
W800 - W1200 x D450 x H1630
W800 - W1200 x D450 x H1800
W800 - W1200 x D450 x H1980
W800 - W1200 x D450 x H2100
W800 - W1200 x D450 x H2400

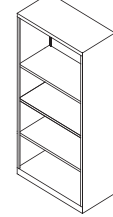

Open Shelf Cabinet
书柜

W800 - W1600 x D450 x H710
W800 - W1600 x D450 x H900
W800 - W1600 x D450 x H1020
W800 - W1600 x D450 x H1250
W800 - W1600 x D450 x H1400
W800 - W1600 x D450 x H1500
W800 - W1200 x D450 x H1630
W800 - W1200 x D450 x H1800
W800 - W1200 x D450 x H1980
W800 - W1200 x D450 x H2100
W800 - W1200 x D450 x H2400

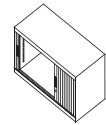

Stackable Roller Shutter Door Cabinet
叠顶卷门文件柜

W800 - W1600 x D470 x H440

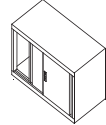

Stackable Sliding Door Cabinet
叠顶移门文件柜

W800 - W1600 x D450 x H440

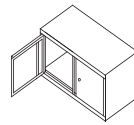

Stackable Hinged Door Cabinet
叠顶掩门文件柜

W800 - W1200 x D450 x H440

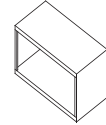

Stackable Open Shelf Cabinet
叠顶书柜

W800 - W1600 x D450 x H440

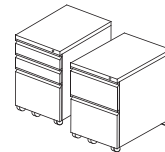

Mobile Pedestal, 2 drawers (FF) or 3 drawers (BBF)
活动抽屉柜, 2斗或3斗

W400 x D500 x H605

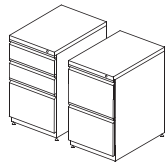

Underdesk Fixed Pedestal, 2 drawers (FF) or 3 drawers (BBF)
台底固定抽屉柜, 2斗或3斗

W400 x D500 x H710

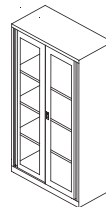

Glass Sliding Door Cabinet
玻璃移门文件柜

W900 x D450 x H710
W900 x D450 x H900
W900 x D450 x H1250
W900 x D450 x H1800

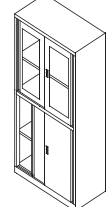

Cabinet w/ Glass & Steel Sliding Door
上玻璃移门下铁移门文件柜

W900 x D450 x H1800



Cabinet w/ Glass & Steel Swing Door
上玻璃移门下双掩门文件柜

W900 x D450 x H1800

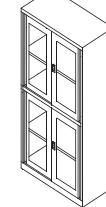

Cabinet w/ 2 Pairs Glass Sliding Door
上下玻璃移门文件柜

W900 x D450 x H1800

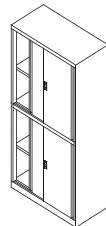

Cabinet w/ 2 Pairs Steel Sliding Door
上下钢移门文件柜

W900 x D450 x H1800

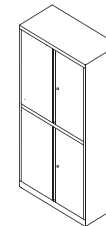

Cabinet w/ 2 Pairs Steel Swing Door
上下钢双掩门文件柜

W900 x D450 x H1800

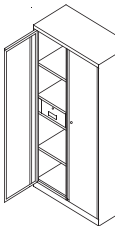

Cabinet w/ Steel Swing Door & 2 Drawers
钢掩门文件柜, 带中二抽斗

W900 x D450 x H1800

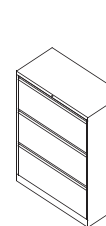

Lateral Filing Drawer Cabinet
横斗式文件柜

2 Drawer 二斗
W800 - 1000 x D450 x H710
3 Drawer 三斗
W800 - 1000 x D450 x H1068
4 Drawer 四斗
W800 - 1000 x D450 x H1388

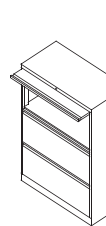

Retractable Door & Lateral Filing Drawer Cabinet
上插门, 横斗式文件柜

2 Drawer 二斗
W800 - 1000 x D450 x H790
3 Drawer 三斗
W800 - 1000 x D450 x H1148
4 Drawer 四斗
W800 - 1000 x D450 x H1468

MCG

钢制文件柜

Statement of Line

详细说明

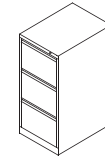

Filing Drawer Cabinet
直斗式文件柜

2 Drawer 二斗
W460 x D635 x H710
3 Drawer 三斗
W460 x D635 x H1010
4 Drawer 四斗
W460 x D635 x H1320

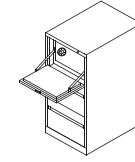

Filing Drawer Cabinet w/ Safe
直斗式文件柜, 带保险箱

2 Drawer 二斗
W460 x D635 x H710
3 Drawer 三斗
W460 x D635 x H1010
4 Drawer 四斗
W460 x D635 x H1320

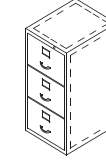

Fire Proof Filing Cabinet
防火直斗式文件柜

2 Drawer 二斗
W520 x D635 x H750
3 Drawer 三斗
W520 x D635 x H1080
4 Drawer 四斗
W520 x D635 x H1410

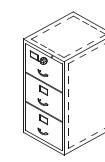

Fire Proof Filing Cabinet w/ Combination Lock
防火直斗式文件柜, 额外带机械式密码锁

2 Drawer 二斗
W520 x D635 x H750
3 Drawer 三斗
W520 x D635 x H1080
4 Drawer 四斗
W520 x D635 x H1410

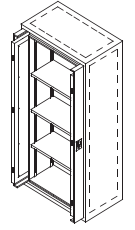

Fire-Proof Filing Cabinet, Retractable Door
防火文件柜, 插门

W889 x D508 x H1778

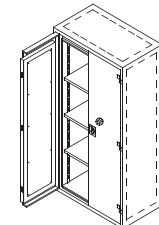

Fire-Proof Filing Cabinet, Double Swing Door
防火文件柜, 双门

W889 x D508 x H1778

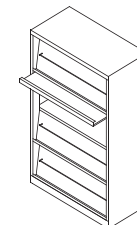

Magazine Cabinet
杂志柜

2 Level 二层
W900 x D450 x H785
3 Level 三层
W900 x D450 x H1123
4 Level 四层
W900 x D450 x H1460
5 Level 五层
W900 x D450 x H1800

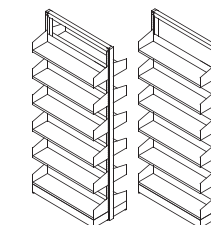

Book Rack
图书架

Single Face 单面
Main Frame 主架 W950 x D250 x H2150
Extension 延伸架 W900 x D250 x H2150
Double Face 双面
Main Frame 主架 W950 x D480 x H2150
Extension 延伸架 W900 x D480 x H2150

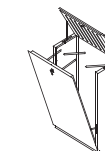

Vertical Plan Chest
直挂图柜

A1 Plan, A1 图柜
W900 x D508 x H1320
A0 Plan, A0 图柜
W965 x D508 x H1450

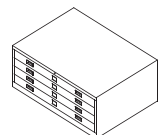

4 Drawers Plan Cabinet
四斗图柜

A1 Plan, A1 图柜
W1220 x D915 x H520
A0 Plan, A0 图柜
W1320 x D965 x H520

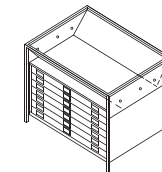

Fluorescent Lamp Table, w/ 7 Drawers
Plan Cabinet
光管台, 连七斗图柜

A1 Plan, A1 图柜
W1220 x D915 x H915
W1068 x D815 x H915

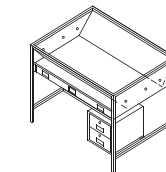

Fluorescent Lamp Table, w/ 1 Drawer
Plan Cabinet & 2 Small Drawers
光管台, 连一大斗图柜及两小斗

A1 Plan, A1 图柜
W1220 x D915 x H915
W1068 x D815 x H915

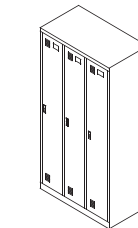

Wardrobe
更衣柜

1 Door 一门
W317 x D500 x H1800
2 Doors 二门
W608 x D500 x H1800
3 Doors 三门
W900 x D500 x H1800

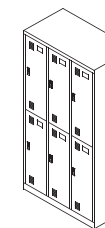

Wardrobe
更衣柜

2 Door 二门
W317 x D500 x H1800
4 Doors 四门
W608 x D500 x H1800
6 Doors 六门
W900 x D500 x H1800

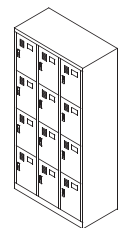

9/ 12/ 15 Doors Locker
九门/ 十二门/ 十五门储物柜

W900 x D450 x H1800

Steel Storage Rack
(Apply for Hong Kong only)
货架 (只供香港地区销售)

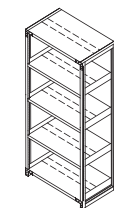

Steel Storage Rack w/ 2/ 3/ 4 Shelves
货架, 带二块/ 三块/ 四块层板

1-Bay 一连
W1000 x D600 x H1800/ H2100/ H2400
W1500 x D600 x H1800/ H2100/ H2400
W2000 x D600 x H1800/ H2100/ H2400
2-Bays 二连
W1962 x D600 x H1800/ H2100/ H2400
W2962 x D600 x H1800/ H2100/ H2400
W3962 x D600 x H1800/ H2100/ H2400

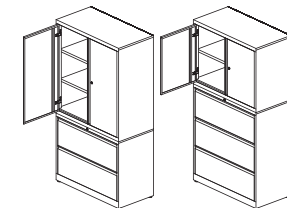

Cabinet w/ Swing Door & 2 Drawers
上掩门下两斗抽屜

W800 - W1000 x D450 x H1170
W800 - W1000 x D450 x H1260
W800 - W1000 x D450 x H1630
W800 - W1000 x D450 x H1800

Cabinet w/ Swing Door & 3 Drawers
上掩门下三斗抽屜

W800 - W1000 x D450 x H1630
W800 - W1000 x D450 x H1800
W800 - W1000 x D450 x H1980
W800 - W1000 x D450 x H2100

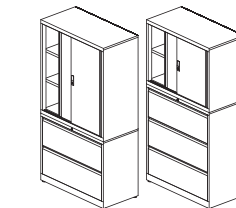

Cabinet w/ Sliding Door & 2 Drawers
上移门下两斗抽屜

W800 - W1000 x D450 x H1170
W800 - W1000 x D450 x H1260
W800 - W1000 x D450 x H1630
W800 - W1000 x D450 x H1800

Cabinet w/ Sliding Door & 3 Drawers
上移门下三斗抽屜

W800 - W1000 x D450 x H1630
W800 - W1000 x D450 x H1800
W800 - W1000 x D450 x H1980
W800 - W1000 x D450 x H2100

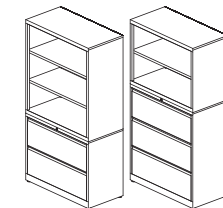

Cabinet w/ Open Shelf & 2 Drawers
上书架下两斗抽屜

W800 - W1000 x D450 x H1170
W800 - W1000 x D450 x H1260
W800 - W1000 x D450 x H1630
W800 - W1000 x D450 x H1800

Cabinet w/ Open Shelf & 3 Drawers
上书架下三斗抽屜

W800 - W1000 x D450 x H1630
W800 - W1000 x D450 x H1800
W800 - W1000 x D450 x H1980
W800 - W1000 x D450 x H2100

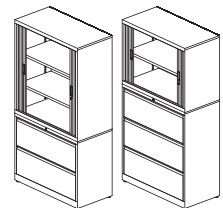

Cabinet w/ Roller Shutter Door & 2 Drawers
上卷门下两斗抽屜

W800 - W1000 x D450 x H1170
W800 - W1000 x D450 x H1260
W800 - W1000 x D450 x H1630
W800 - W1000 x D450 x H1800

Cabinet w/ Roller Shutter Door & 3 Drawers
上卷门下三斗抽屜

W800 - W1000 x D450 x H1630
W800 - W1000 x D450 x H1800
W800 - W1000 x D450 x H1980
W800 - W1000 x D450 x H2100